

Specification For Approval

Customer: _____

Battery model name: 601230

Customer model number: _____

Revision: V0

Date: 2023-07-25

Customer approval
Comment
Customer's signature/ Date : _____

Prepared	Checked	Approved

Hui Zhou Jia Xin Rui NewEnergy Technology Co.,LTD

TEL: 0752-8227236 FAX: 0752-8227236

website: [http:// www.jiaxinrui.cn](http://www.jiaxinrui.cn)

Content

1. Scope	3
2. Model: JXR601230	3
3. Dimensions of battery pack	3
4. Battery configuration	4
5. Specification of cell	5
6. Battery Cell Performance Criteria	6
7. PCM parameter	8
8. Packing Storage and Transportation	11
9. Use Attentions	12

1.Scope

This document describes the Product Specification of the Lithium-Polymer rechargeable battery cell supplied by JXR Corporation Limited).

2、 Model: JXR601230

3.Dimensions of battery pack

T: $\leq 6.2\text{mm}$ * W: $\leq 12.5\text{mm}$ * H : $\leq 33.0\text{mm}$, L=100mm $\pm 5\text{mm}$ 。

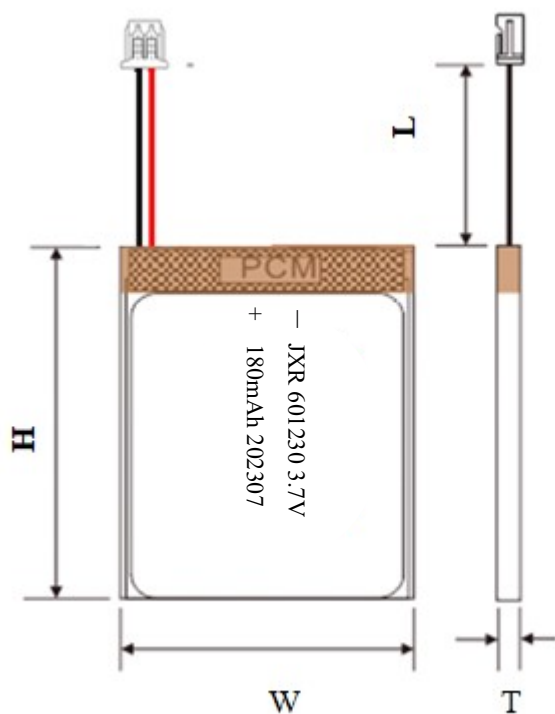

- Connecting Wires
- Red: connect to “+”
- Black : connect to ground “ — ”

4. Battery configuration

4.1 Battery portfolio primarily BOM

No.	Item	Criteria	Remarks
1	Semi-manufactured cell	601230	
2	PCM	TYD-0840	
3	Wire/connector	UL3302AWG28#+JST PH2.0	

4.2 Specifications of battery pack

电池组规格

No.	Item	Specifications	Comments
1	Assemble mode	Simple link	
2	Typical capacity	180mAh	
3	Factory voltage	$\geq 3.80V$	
4	Rated Impedance	$\leq 380m\Omega$ normal temperature 25°C	
5	Dimensions (mm)	≤ 6.2 (T) * ≤ 12.5 (W) * ≤ 33.0 (H) (mm)	
6	Overcharge protection voltage	$4.28V \pm 0.025V$	
7	Max. charge current	1.0C	
8	Over discharge protection voltage	$3.0V \pm 0.05V$	
9	Max discharge current	1.0C	
10	Charge temperature	0°C ~ +45°C	
11	Discharge temperature	-10°C ~ +55°C	
12	Storage temperature	less than 1 month	-10~+55°C
		less than 3 month	-10~+40°C
		less than 1 year	0~+25°C
13	Storage humidity	$\leq 75\%$	

Hui Zhou Jia Xin Rui NewEnergy Technology Co.,LTD

5. Specifications of cell

No.	Items	Specifications	
1	Charge voltage	4.2V	
2	Nominal voltage	3.7V	
3	Charge current	Standard Charging: 0.2 C Rapid charge: 1.0 C	
4	Standard Charge	Charging the cell initially with constant current at 0.2 C and then with constant voltage at 4.2V till charge current declines to 0.02 C	
5	Charging time	Standard Charging: 6.0 hours (Ref.) Rapid charge: 1.5-2.5 hours (Ref.)	
6	Max.charge current	1.0 C	
7	Max.discharge current	1.0C	
8	Discharge cut-off voltage	3.0V	
9	Charge temperature	0°C ~ +45°C	
10	Discharge temperature	-10~+55°C	
11	Temperature range for storage	less than 1 month	-10~+55°C
		less than 3 month	-10~+40°C
		less than 1 year	0~+25°C
12	Cell Weight	Approx: g 约: g	
13	Cell Dimension	Length : 30.5mm Max (not including tabs) Width : 12.5mm Max Thickness : 4.2mm Max	

6.Battery Cell Performance Criteria

6.1 Electrical characteristics

No.	Items	Test Method and Condition	Criteria
1	Standard Charge	Charging the cell initially with constant current at 0.2 C and then with constant voltage at 4.2V till charge current declines to 0.02 C	
2	First Discharge Capacity	The capacity means the first discharge capacity of the cell, which is measured with discharge current of 0.5C with 3.0V cut-off after standard charge. 1.0C 0.5C charge-discharge capacity of 3.0V cutoff emitted $\geq 180\text{mAh}$	$\geq 180\text{mAh}$
3	Cycle Life	Test condition: Charge: 0.2C to 4.2V Discharge: 0.2C to 3.0V Cycle life decreased when the discharge capacity is 80% of the initial capacity, cycle times for the definition of the finished battery	≥ 300 (laps)
4	Self-discharge	After the standard charging, storied the cells under the condition $25.0 \pm 5.0^\circ\text{C}$ (Temperature) $\leq 75.0\%\text{RH}$ (Humidity) for 28 days, then measured the capacity with 0.2 C till 3.0V with previous standard discharge capacity of the ratio	Residual capacity $> 90\%$
5	Initial impedance of cell	Internal resistance measured at AC 1KHz after 50% charge , at 25°C .	$\leq 280\text{m}\Omega$
6	Temperature Characteristics	1. According to item 4.2.5, at $25 \pm 5^\circ\text{C}$. 2. Capacity comparison at each temperature, measured with constant discharge current 0.2 C with 3.0V cut-off. Percentage as an index of the capacity compared with 100% at 25°C	-20°C : $\geq 50\%$ 25°C : 100% 60°C : $\geq 85\%$
7	Constant humidity and temperature	After standard charging, laying the battery 48h at $40 \pm 2^\circ\text{C}$, RH $93 \pm 2\%$. Recording 1C discharging time	No distortion No electrolytes leakage

8	Short circuit protection	Short of its positive and negative 1h, shorted wire resistance $80 \pm 20m\Omega$.	Should not leak, he was never discouraged, not broken, no fire, no explosion.
9	Batteries overcharge test	I At standard testing condition, charging the battery to 4.6V with 3C until the charge current decrease to 0. Stop test until the battery temperature descend for $10^{\circ}C$ than peak value.	no fire, no explosion.

6.2 Mechanical characteristics

No.	Items	Test Method and Condition	Criteria
1	Vibration Test	After standard charging, fixed the cell to vibration table and subjected to vibration cycling that the frequency is to be varied at the rate of 1Hz per minute between 10Hz and 55Hz, the excursion of the vibration is 1.6mm.The cell shall be vibrated for 30 minutes per axis of XYZ axes.	No leaks, no fire, the battery can work normally, the resistance rate of change is less than or equal to 10%, voltage holding ratio (after shock voltage / initial voltage * 100%) greater than or equal to 90%
2	Drop Test	The cell is to be dropped from a height of meter twice onto concrete ground.	No leaks, no fire, the battery can work normally, the resistance rate of change is less than or equal to 10%, voltage holding ratio (after shock voltage / initial voltage * 100%) greater than or equal to 90%
3	Squeeze test	Battery cells installed in the extrusion stage, with two flat squeeze Flat surface pressure of the battery, a plate shape having a diameter of 1.25 inch circle. Extrusion pressure regulator, the battery contacts Surface to withstand maximum pressure reached 17.2Mpa. Test was stopped when the pressure reaches maximum.	no fire, no explosion.

Hui Zhou Jia Xin Rui NewEnergy Technology Co.,LTD

4		Battery is placed in the hot oven, the temperature at a rate of $(5\text{ }^{\circ}\text{C} \pm 2\text{ }^{\circ}\text{C}) / \text{min}$ heating to $130\text{ }^{\circ}\text{C} \pm 2\text{ }^{\circ}\text{C}$ and incubated 30min.	no fire, no explosion.

6.3 Visual inspection

There shall be no such defect as scratch, flaw, crack, and leakage, which may adversely affect commercial value of the cell.

6.4 Standard environmental test condition

Unless otherwise specified, all tests stated in this Product Specification are conducted at below condition:

Temperature: $25.0 \pm 5.0^{\circ}\text{C}$

Humidity: $\leq 75.0\% \text{RH}$

7. PCM parameter PCM 参数

7.1 PCM 参数

项目	符号	详细内容	标准
Overcharge protection	V_{DET1}	Overcharge detection voltage	$4.28V \pm 0.025V$
	tV_{DET1}	Overcharge detection delay time	1.2s (MAX)
	V_{REL1}	Overcharge release voltage	$4.08V \pm 0.05V$
Over discharge protection	V_{DET2}	Over discharge detection voltage	$3.0V \pm 0.05V$
	tV_{DET2}	Over discharge detection delay time	173ms (MAX)
	V_{REL2}	Over discharge relief voltage	Charge off
Over current protection Short circuit protection	V_{DET3}	Over current detection voltage	$80mV \pm 15mV$
	I_{DP}	Discharge over current protection current	MIN: 1.3A MAX: 3.0A
	tV_{DET3}	Detection delay time	10ms (MAX)
		Conditions for release of protection	Disconnect the load
		Protection conditions	External circuit short circuit
	T_{SHORT}	Detection delay time	$400 \mu s$ (MAX)
		Conditions for release of protection	Disconnect the short circuit
internal resistance	R_{DS}	On state resistance of main circuit (battery voltage = 3.9v)	B-to P- $R_{DS} \leq 60m\Omega$
Current consumption	I_{DD}	Circuit internal consumption during operation	MIN: $0.3 \mu A$ MAX: $6.0 \mu A$
Function of charging 0V battery		/	allow

7.2 PCB component list

保护板主要元件清单

Serial number	Component number	Component name	Component specification	Packaging form	number
1	U1	IC	S8261ABJMD-G3J	SOT-23-6	1
2	U2	MOSFET	8205A	SOT-23-6	1
3	R1	resistance	SMD $470 \Omega \pm 5\%$	0402	1
4	R2	resistance	SMD $2K \Omega \pm 5\%$	0402	1
5	C1	resistance	SMD $0.1 \mu F \pm 20\%$	0402	1
6	PCB	Printed circuit board	$8.0mm * 4.0mm * 0.6mm \pm 0.15mm$		1

7.3 Application Schematic

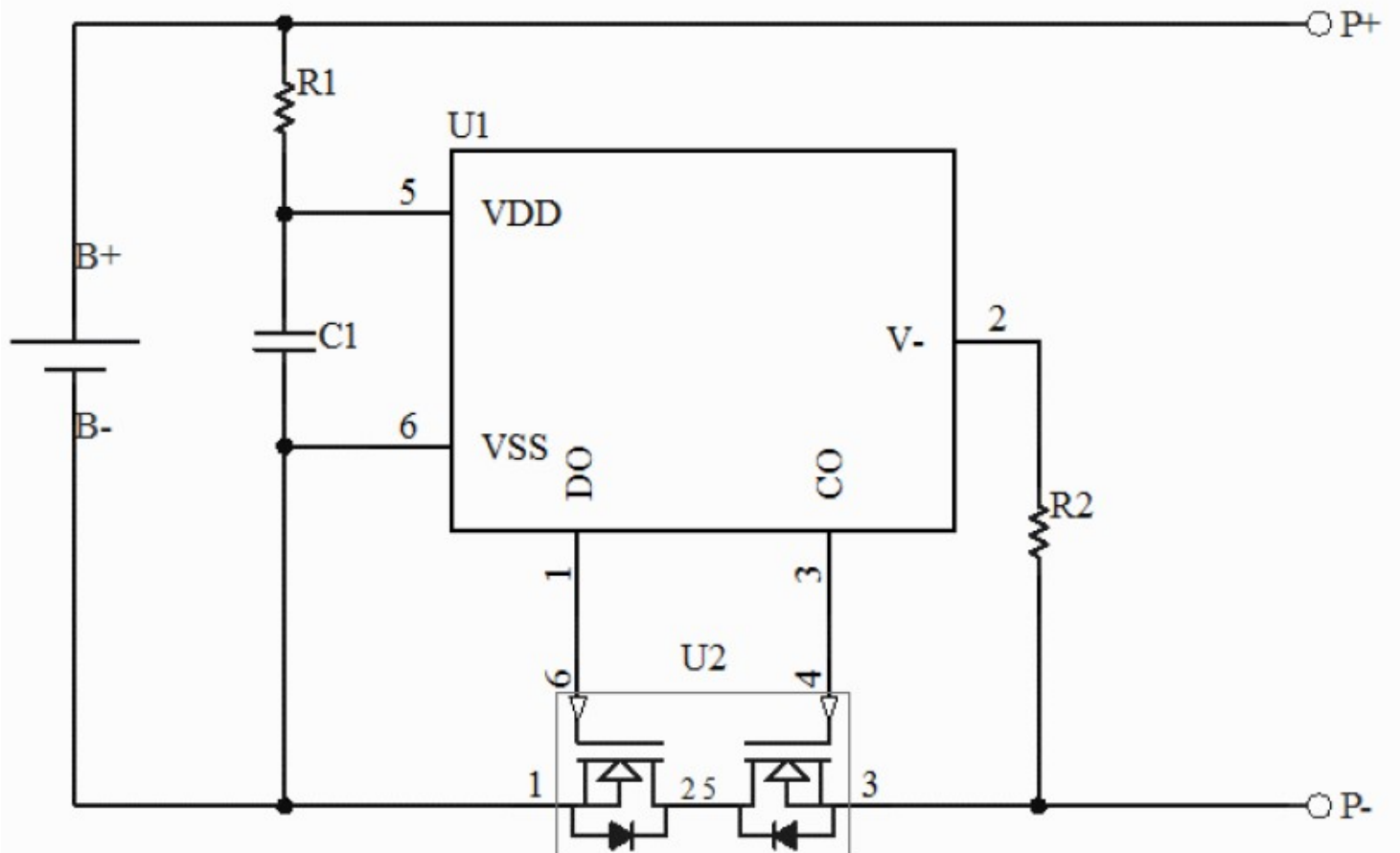

8. Packaging、 Storage and Transportation

8.1 Packaging model

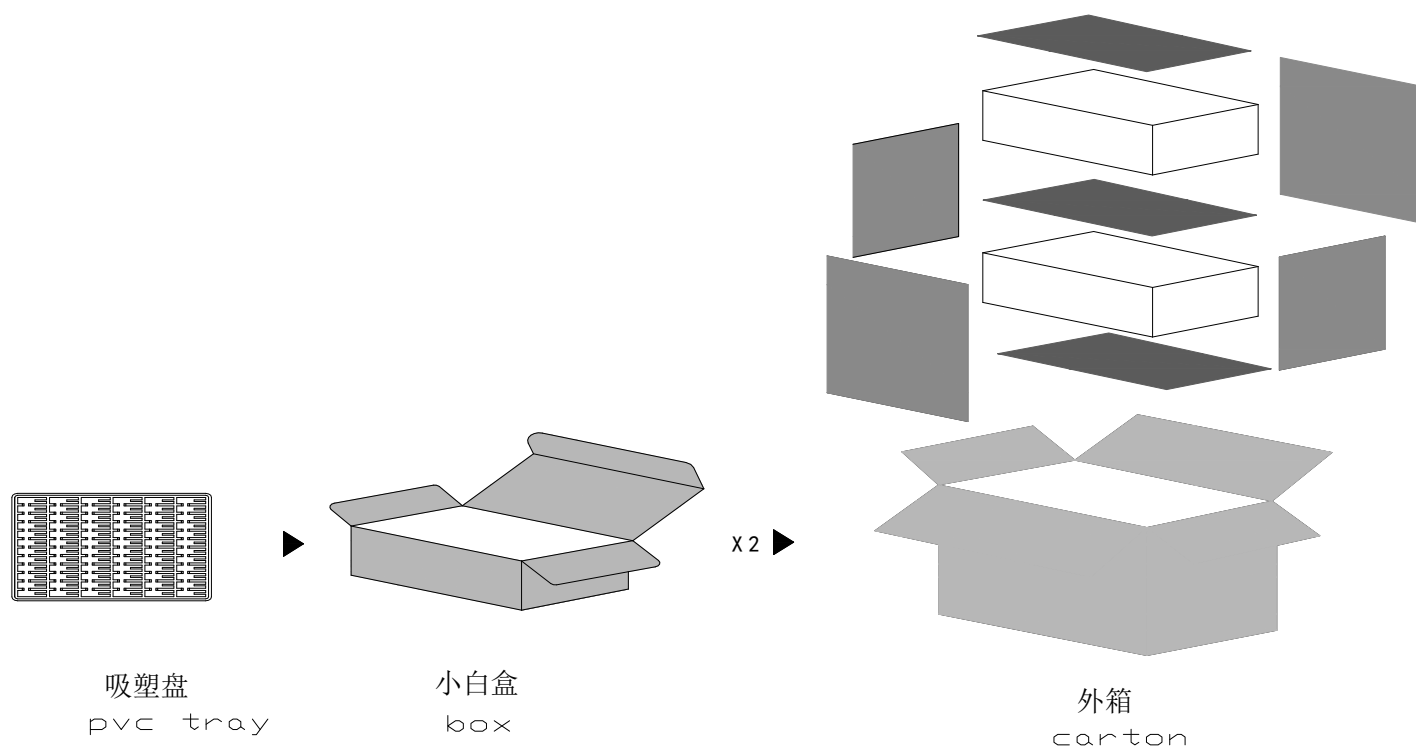

8.2 Storage 儲存:

8.2.1 The Li-ion battery pack should be stored in a cool, dry and well-ventilated area, and should be far from the fire and the high temperature.

8.2.2 The battery should store in the product specification book stipulation temperature range, the best storage temp. is $25 \pm 5^{\circ}\text{C}$. The best humidity is $60 \pm 15\%$.

8.2.3 The battery should be stored within room temperature, and charged to 40%~60% electric quantity (3.85V) . In order to avoid over-discharge, we suggest charge and discharge the batteries every three months.,Then charge to40%~60%electric quantity(3.85V).

8.3 Transportation 8.3.1 Do not mix the battery products with other car gos.

8.3.2 Do not immerse the battery products in water or allow it to get wet.

8.3.3 Do not over 7 layers staking and upside-down.

8.3.4 The highest temperature in transportation is lower than 65°C .

9. Use Attentions

To ensure proper use of the battery please read the manual carefully before using it.

9.1 Warnings:

9.1.1 Do not expose to, dispose of the battery in fire.

9.1.2 Do not put the battery in a charger or equipment with wrong terminals connected.

9.1.3 Avoid shorting the battery.

9.1.4 Avoid excessive physical shock or vibration.

9.1.5 Do not disassemble or deform the battery.

9.1.6 Do not immerse in water.

9.1.7 Do not use the battery mixed with other different type or model batteries.

9.1.8 Keep out of the reach of children.

9.2 Charge 充电:

9.2.1 Battery must be charged in appropriate charger only.

9.2.2 Never use a modified or damaged charger.

9.2.3 Do not leave battery in charger over 24 hours.

9.2.4 Charging current: Can not surpass the biggest charging current which in this specification book stipulated.

9.2.5 Charging voltage: Does not have to surpass the highest amount which in this specification book stipulated to decide the voltage.

9.2.6 Charge temperature: The battery must carry on the charge in the ambient temperature scope which this specification book stipulated.

9.2.7 Uses constant current and constant voltage way charge. PLS connect the positive and negative terminals in right way, or the battery may be damaged.

9.3 Discharge:

9.3.1 The discharging current should not surpass the biggest discharging current this specification book stipulation, The large discharge current can cause heat and lower capacity.

9.3.2 Discharge temperature: The battery discharge must carry on in the ambient temperature scope which this specification book stipulated.

9.3.3 Over-discharge: After short time over discharge, then charge immediately won't damage the battery. But the battery will be damaged for being long time over discharged. During long-term storage, the battery may be within over-discharging condition for self discharge. To prevent the occurrence of over discharging, the battery should maintain the certain capacity when storage.

9.4 Handling of Cells

1 Soft Al foil

- Don't strike battery with any sharp edge parts
- Trim your nail or wear glove before taking battery
- Clean worktable to make sure no any sharp particle

2 Sealed edge may be damaged by heat above 100°C, bend or fold sealed edge.

3 Handling of Tabs

The battery tabs are not so stubborn especially for aluminous tab.

Do not bend tabs unnecessarily.

4 Tab Connection

Ultrasonic welding or spot welding is recommended for LIP tab connection method.

Battery pack should be designed that shear force are not applied to the LIP tabs.

If apply manual solder method to connect tab with PCM, below notice is very important to ensure battery performance:

- The solder iron should be temperature controlled and ESD safe;
- Soldering temperature should not exceed 370°C;
- Soldering time should not be longer than 3s;
- Soldering times should not exceed 5 times, Keep battery tab cold down before next time soldering;
- Directly heat cell body is strictly prohibited, Battery may be damaged by heat above approx. 100°C

9.5 Disposal:

Regulations vary for different countries. Dispose of in accordance with local regulations.

9.6 Note:

Any other items which are not covered in this specification shall be agreed by both parties.